

Data Sheet



Article number: 03503040

Description: Fluro Rod end GE 40HO-2RS

Measures

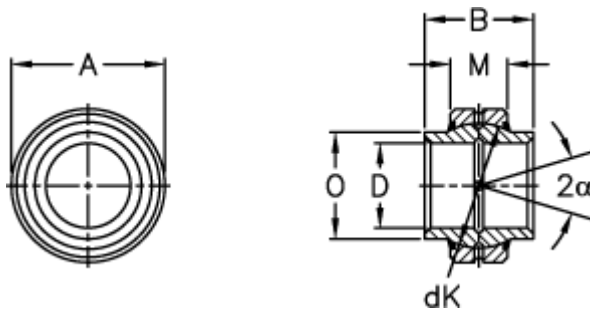

A	= 62 0 -0,013	Tilt angle = 3
B	= 38	Weight = 320
D	= 40 0 -0,012	
dK	= 53	
Dynamic load C (kN)	= 100	
M	= 22	
O	= 45	
Static load C0 (kN)	= 500	